

Sink S4001

Kitchen Sinks

Code: 3357 050



DETAILS

Edge/Installation Type	Flush-mount Top-mount
Finish	Foster brushed
Material	AISI 304 stainless steel
Texture	Brushed in line
Base	80 cm
Dimensions	750x440 mm
Standard fittings	Fixing hooks, gasket, drain, overflow and siphon, boxed packing
Mixer holes	No standard holes
Built-in hole	View technical data sheet

Drainer	No
Width	75 cm
Bowl dimension	710x400mm
Number of bowls	1 bowl
Waste fitting	Drain SPACE 3,5"

FEATURES

High thickness	1mm thick steel. A significant thickness, which guarantees the maximum sturdiness and durability.
Space waste fitting	The elegant SPACE steel cap closes the drain and leaves no visible residues collected in the basket below. Space also has a small footprint and allows the optimal use of the under-sink compartment.
Save space system	Drain and siphon are designed to leave as much space as possible in the under-sink area, more and more useful today for theseparate waste collection systems.
Perimetral overflow	The overflow is always a security on the Foster sinks that prevents the overflow of water in case of oversights. The perimeter drain solution improves aesthetics thanks to its square and essential shape.
Small radius	Bowls with squared shapes with a modern design and an increased capacity, for a minimal aesthetics connected with an extreme practicality.
Deep bowls	This bowls reach an important depth, over 20 cm, thanks to the advanced production technology, that can be offer great capieny and practicality in all the washing operations.

TECHNICAL DATA



Lavello / Sink cod. 3357/050

intaglio per il troppo-pieno
solo con top > 30 mm

recess for housing the over-flow
only for top > 30 mm

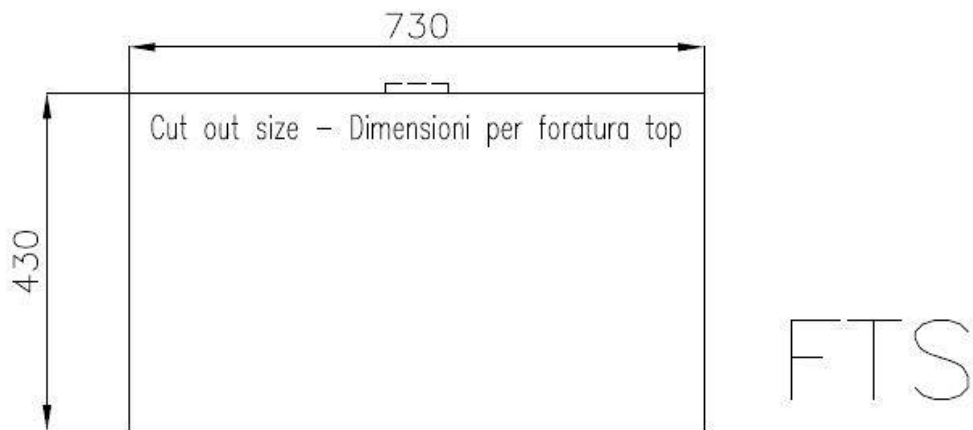
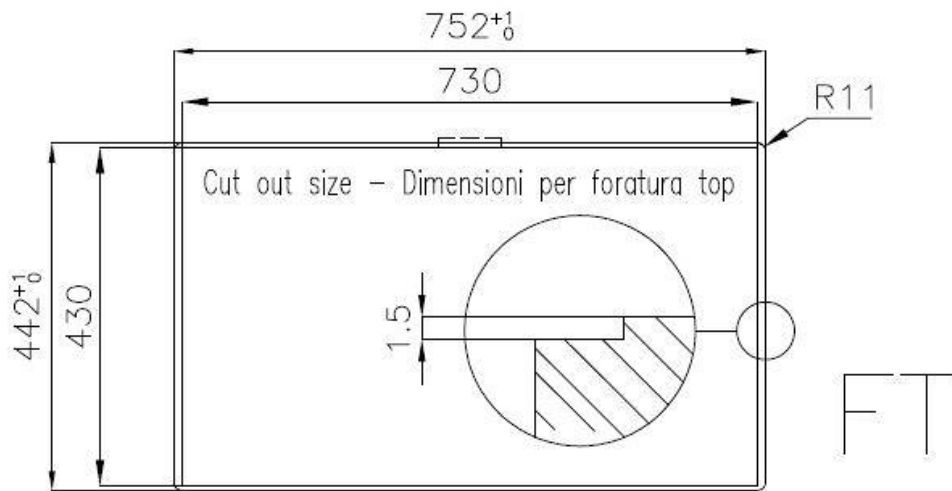
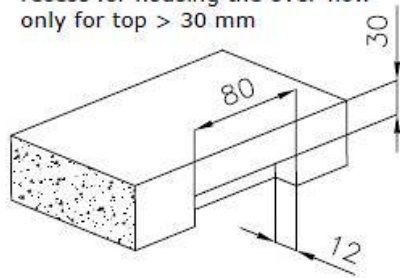

OPTIONAL ACCESSORIES



Cestello inox
8612 000



Glass chopping board
8631 300



HPDE Chopping board
8657 001



HPDE Twin chopping board
8644 101



Stainless steel colander
8154 000



Stainless steel plate rack
8100 154



Stainless steel plate rack
8100 303

* only in combination with the accessory
8644 101

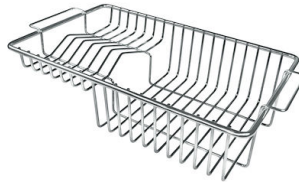

Stainless steel plate rack
8100 201



White bowl
8153 100



**Graters kit with ring-holder and
food collection tray**

8159 101

* only in combination with the accessory
8644 101



Stainless steel perforated tray

8151 000

* only in combination with the accessory
8644 101

OPTIONAL AUTOMATIC WASTE FITTINGS



Automatic waste fitting
8407 113



Space automatic waste fitting
8407 108



Space automatic waste fitting
8407 109



Space Light automatic waste fitting
8407 117



Space Milano automatic waste fitting
8407 115



Space Push automatic waste fitting
8407 116